



CHOICE ENCLOSURES

BY REPLICATIONS UNLIMITED

DUMPSTER ENCLOSURE PARTS LIST

SCREWS & BOLTS

A1



ACC 1510-7
7" x 1/2" Anchor Bolt

A2



ACC 1510-4.5
4.5" x 1/2" Anchor Bolt

B1



ACC 1520-1
1" x #12 Self Tapping

B2



ACC 1515
1" x #12 Self Tapping

FOR METAL TRIM



ACC 1526-1
1" x #10 Self Tapping

FOR STONE/BRICK PANELS



ACC 1504-2.5
2.5" x #09

FOR STUCCO



ACC 1525-75
3/4" x #10

MODULAR FRAME

6' Starter Post

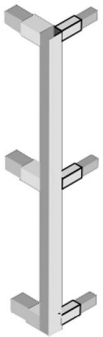

6' Inline Post

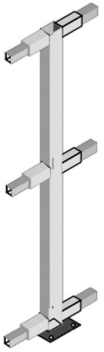

6' Corner Post

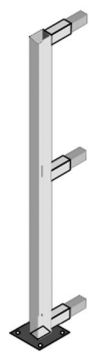

8' Corner Post

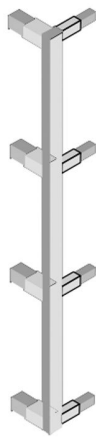

8' Inline Post

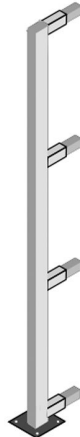

8' Starter Post

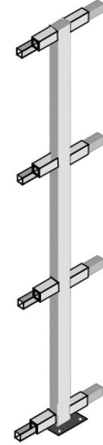

A2



ACC 1510-4.5
4.5" x 1/2" Anchor Bolt

SCREW & BOLT DIRECTLY
ONTO CONCRETE

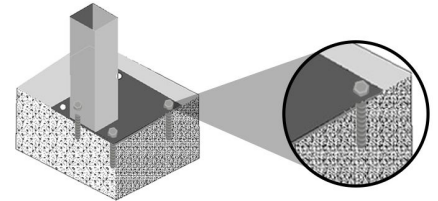

INTERLOCKING BEAM

6 FT

8 FT

10 FT

A1



ACC 1510-7
7" x 1/2" Anchor Bolt

Corner Post



Inline Post

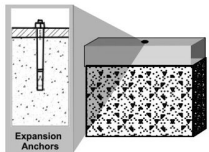

• SCREW & BOLT
BASE BEAM
DIRECTLY ONTO
CONCRETE

6 FT

8 FT

10 FT

Starter Post

SUPPORT POSTS



CE2008-8
Support Posts 8'



CE2008-6
Support Posts 6'



MT1640-2.75
Metal Cap

B1



ACC 1520-1
1" x #12 Self Tapping



A2



ACC 1510-4.5
4.5" x 1/2" Anchor Bolt

Metal Cap

Post Base

METAL SIDING VERTICAL AG PANEL



MT1601-6/8 (6' or 8')
AG Panel ++ Metal Panel for Enclosure

Reversed AG Panel



Standard AG Panel

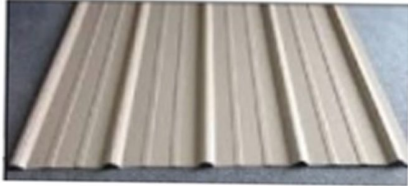

B1



ACC 1520-1
1" x #12 Self Tapping

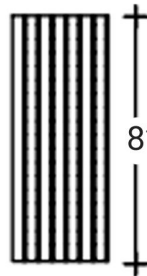
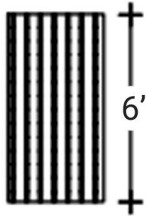

METAL SIDING HORIZONTAL M PANEL



MT1603-8/8 (6' or 8')
M Panel Horizontal Metal Panel

B1



ACC 1520-1
1" x #12 Self Tapping

BACK TO J-TRIM

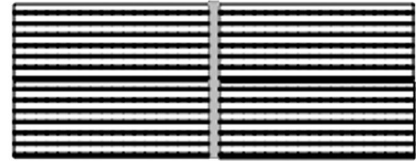

HORIZONTAL SIZE
VARIES



TYPICALLY 5-8ft WIDE

J-TRIM



METAL TRIM

Used to Cap the Top and Front of the Enclosure



MT1640
Top Cap

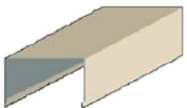

MT1642
Front Cap

Width Varies Depending if the Enclosure is A Metal, Brick, or Stone Enclosure.

B2



ACC 1515
1" x #12 Self Tapping

METAL J-TRIM

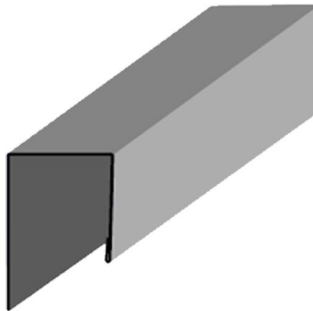

MT1686-.75
J-Trim

FOR METAL TRIM



ACC 1526-1
1" x #10 Self Tapping

CORNER

On Metal Enclosures Only

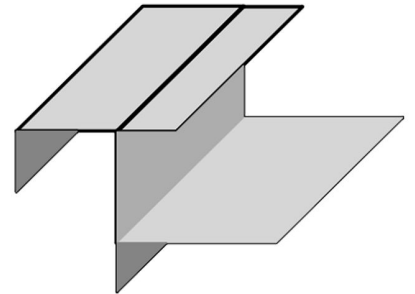

Use Two
J-Trims
Back to Back



FOR METAL TRIM



ACC 1526-1
1" x #10 Self Tapping

STONE EXTERIOR

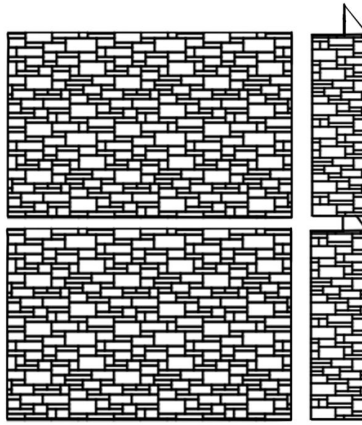
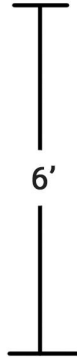
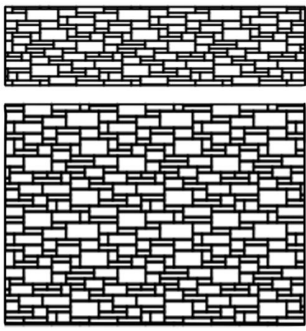

CUSTOM CORNERS
OPTIONAL

BRICK EXTERIOR

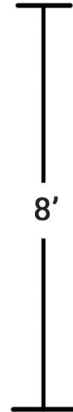
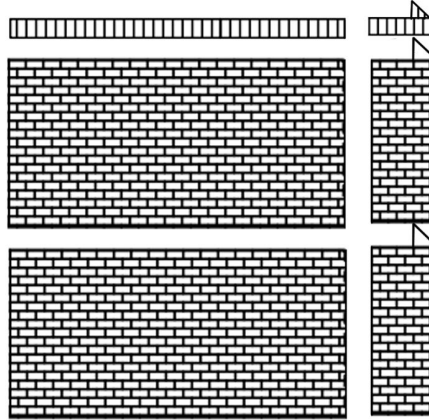
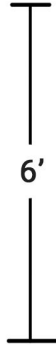
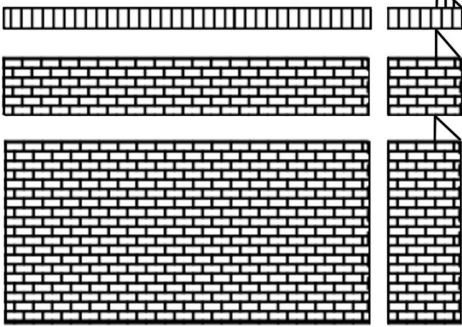

CUSTOM CORNERS
OPTIONAL

KING BRICK EXTERIOR

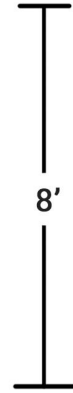
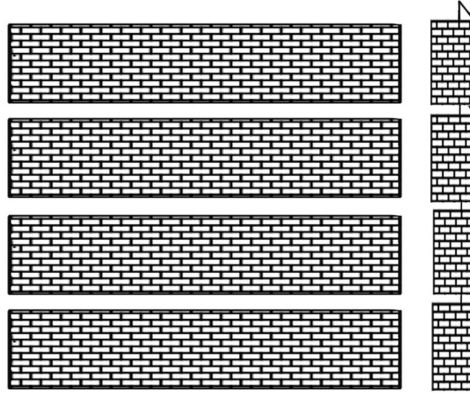
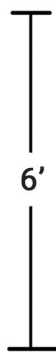
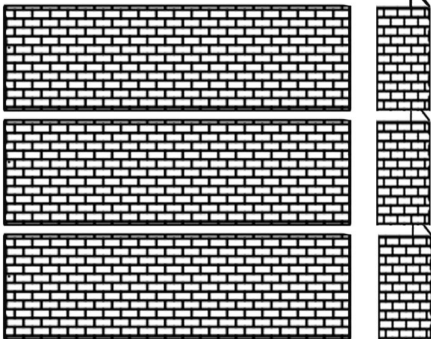

CUSTOM CORNERS
OPTIONAL

STUCCO EXTERIOR

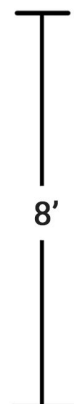
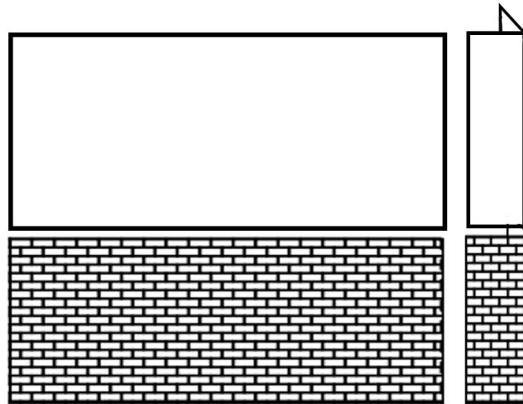
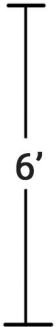
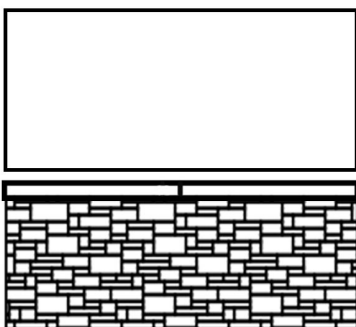

*Apply screw from inside

GATE POSTS

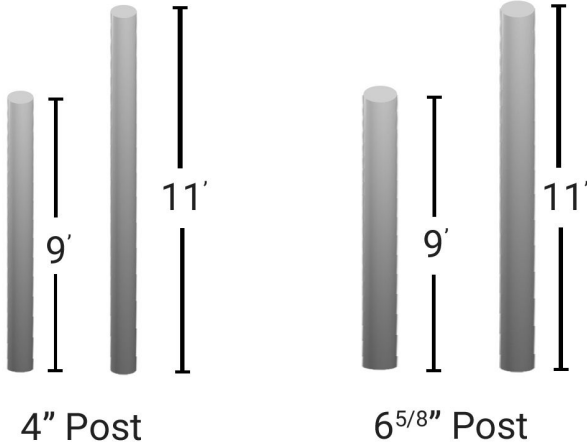

GATE FRAME

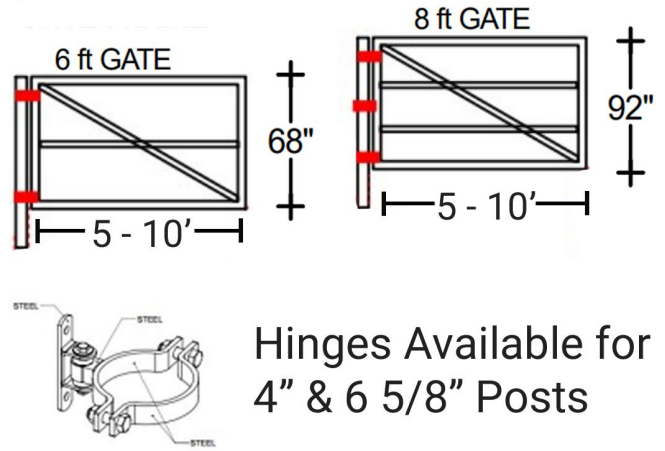

MAN GATE

3ft Wide Man Gate Specification

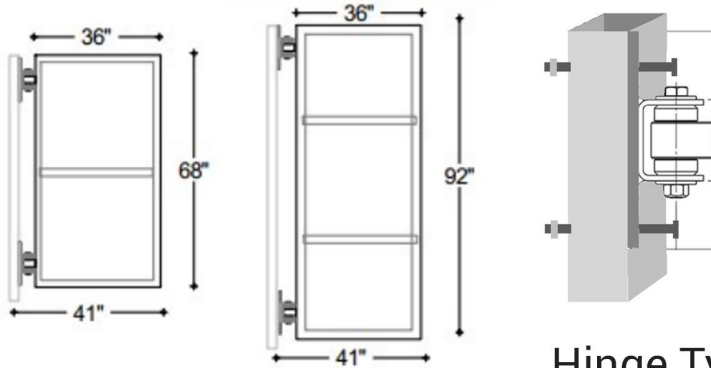

4ft Wide Man Gate Specification

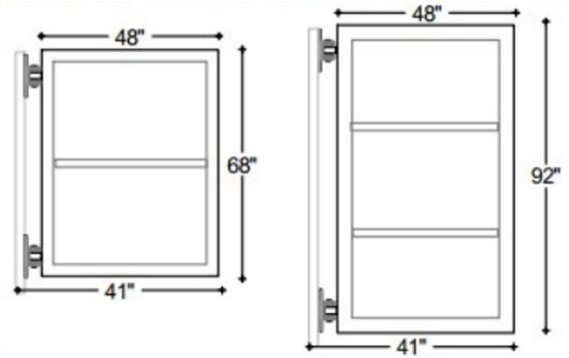

Hinge Typically Bolts to Framing System

GATE

AG-PANEL

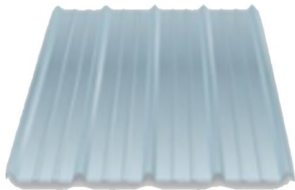

VERTICAL SIDING

M-PANEL



HORIZONTAL SIDING

Typically panel color is reversed for gates



B1



ACC 1520-1
1" x #12 Self Tapping

GATE TRIM

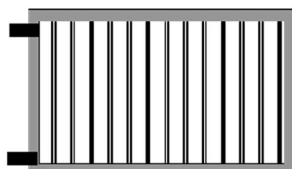

MT1686-.75
J-Trim

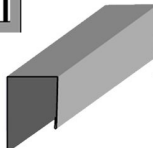

FOR METAL TRIM



ACC 1526-1
1" x #10 Self Tapping

Trim used for the perimeter of gate.

LATCH & BOLT



LATCH AND
CAIN BOLTS
BUILT INTO THE
GATE FRAME